

4CIS[®]

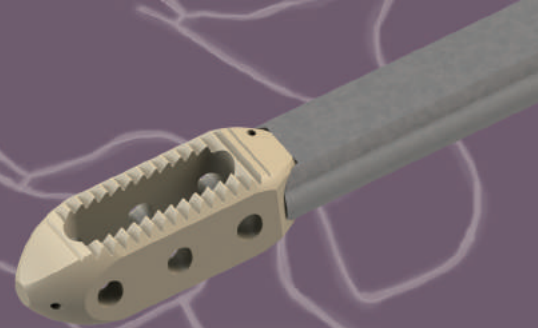

PEEK PLIF

Cage System

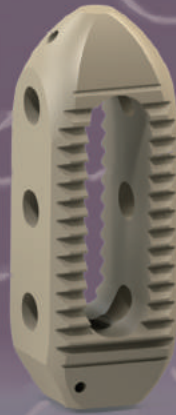
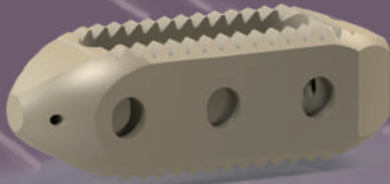
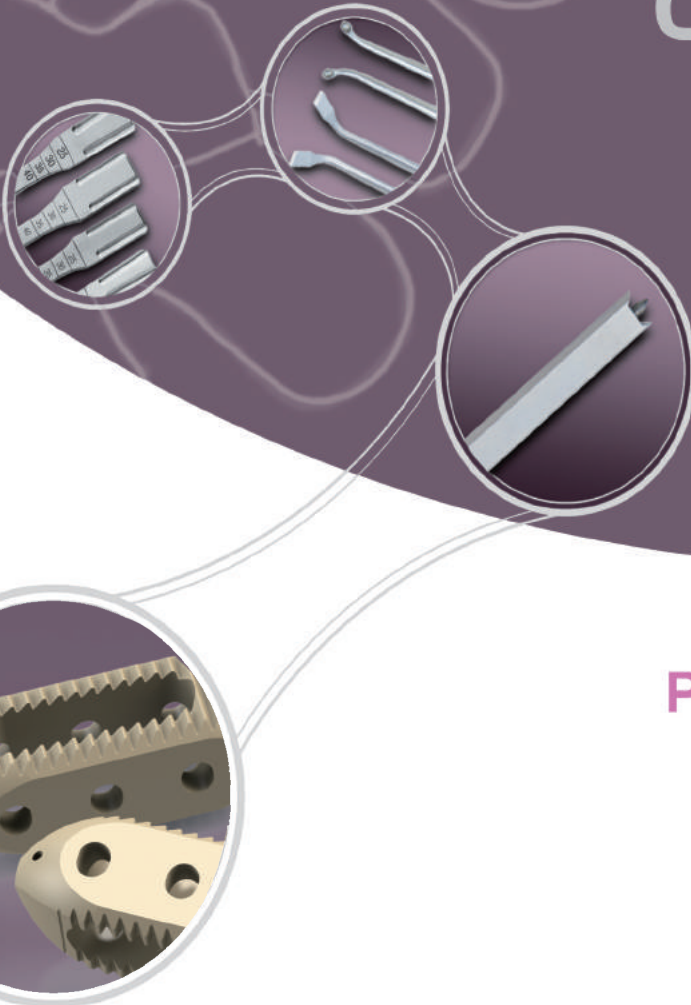

PEEK PLIF Cage System

PEEK has the better modulus of elasticity to the cancellous bone than any other materials, such as a metal or a carbon fiber

US FDA Approved
No.3004941535

CE
0434

SOLCO.
LIFE & SCIENCE

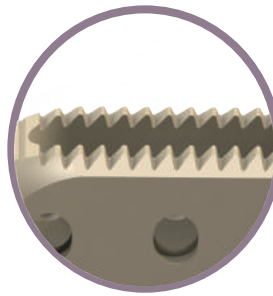
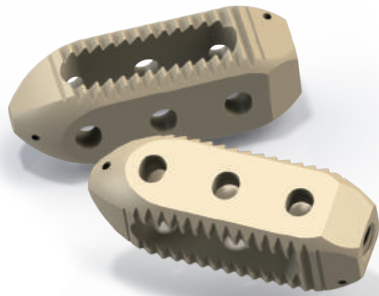

A Serrated design to prevent cage sliding

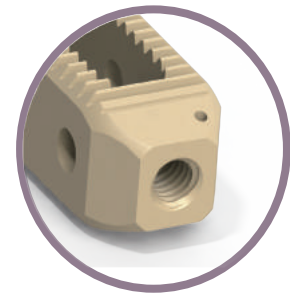

Easy to couple and uncouple

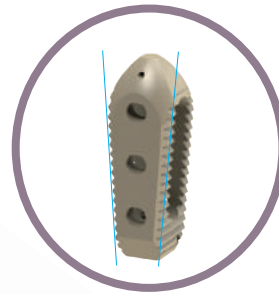

A Lordotic configuration (0°, 4°, 8°)



Easy insertion

A Wide Fusion Area

Compared with other cages, it has a wide fusion area which guarantees the high union rate.

Anatomy Friendly

The bullet type cage has an anatomical similarity with the endplate.



C o n t e n t s

Surgical Procedure

- Patient Positioning _04
- Surgical Exposure _05
- Distraction of the Vertebral Body _05
- Distraction of the Endplates _06
- Distraction of the Endplates, Continued _07
- Insertion and Rotation _07
- Implant Insertion, Continued _08
- Implant Insertion, Continued _09
- Closure _09

PEEK PLIF Cage System Implants / Instruments List

_10

Surgical Techniques

1. Patient Positioning

The laminae and the articular processes are exposed laterally to the base of the transverse processes.

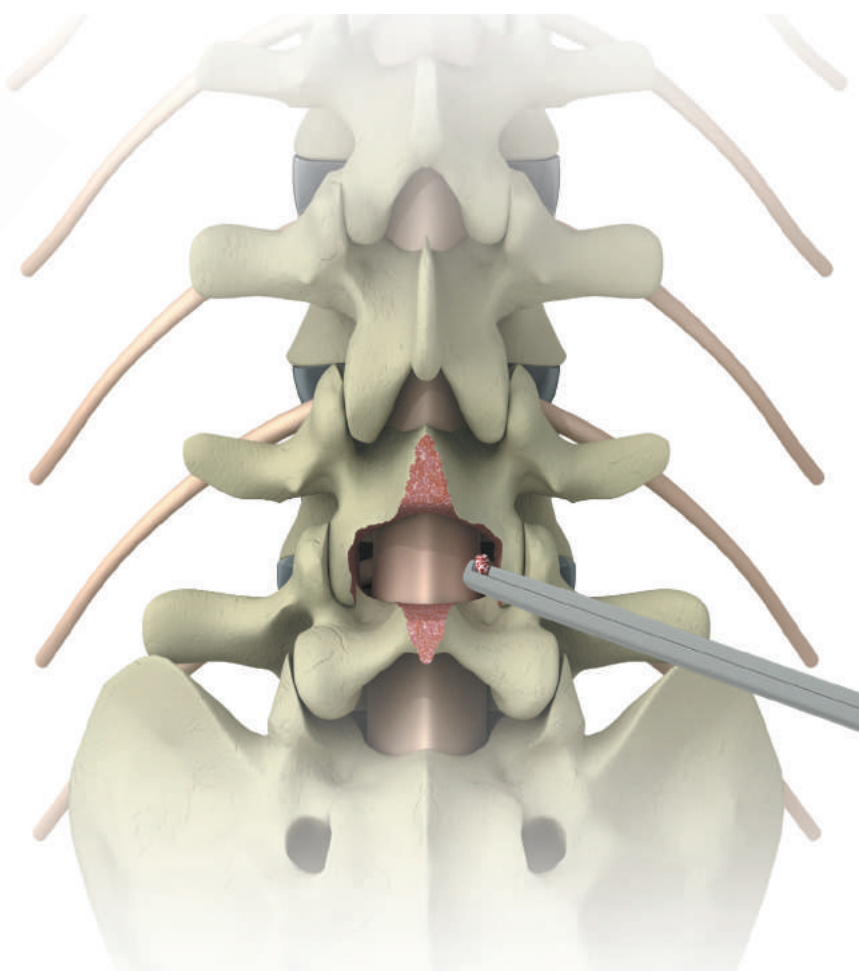
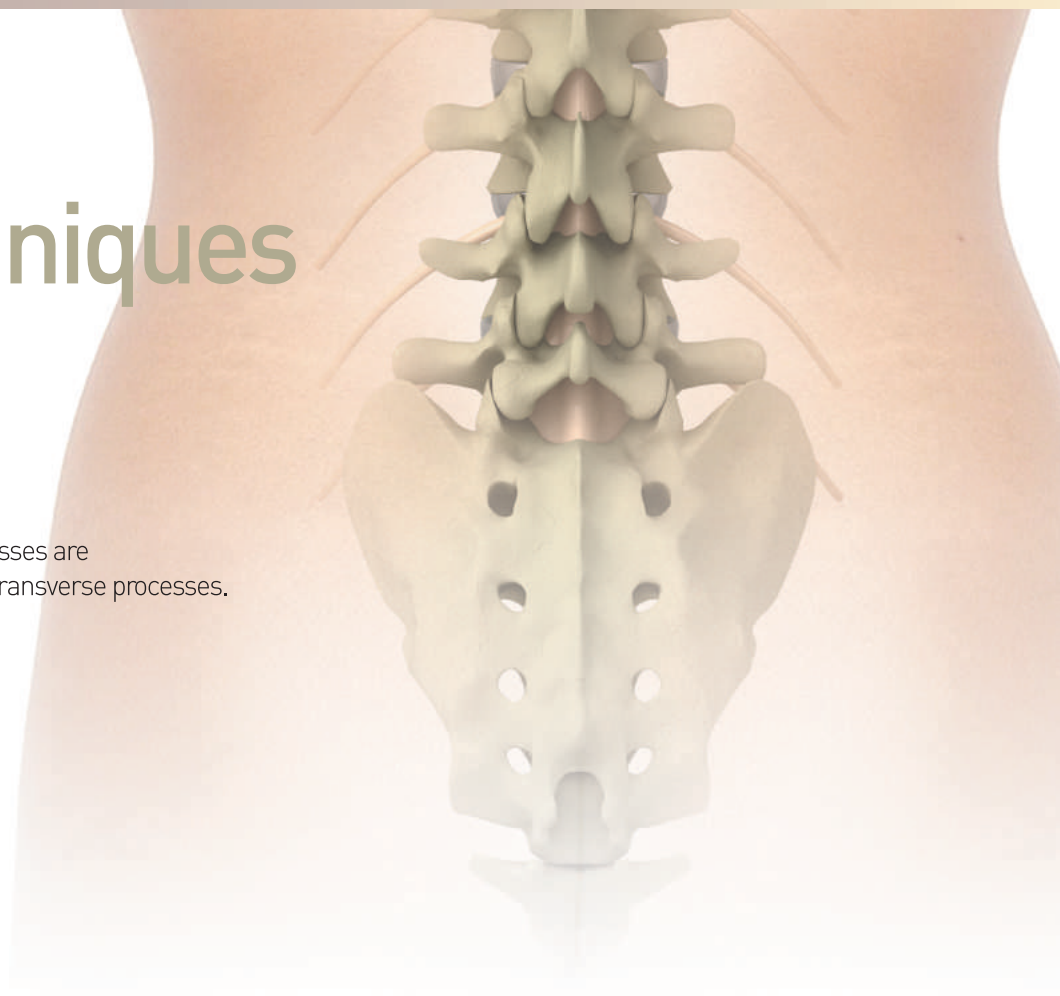

2. Surgical Exposure

The spinal canal is opened by excision of the laminae and the articular processes. The laminectomy is extended laterally until reaching the level of the medial edge of the pedicle. The excision also includes half of the inferior articular process of the superior vertebra.

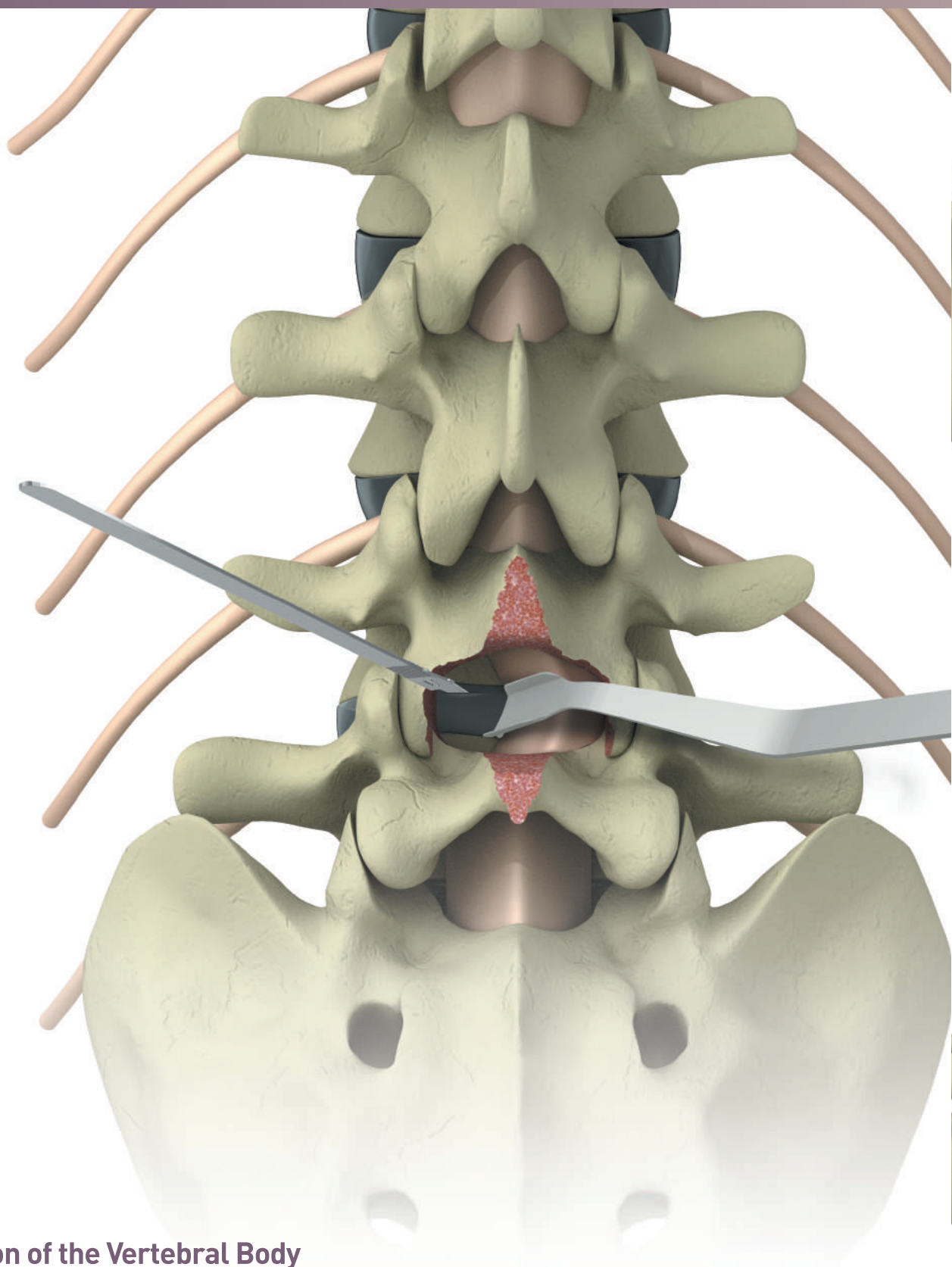

3. Distraction of the Vertebral Body

The dura meter retractor is used to retract the dura medially to expose the posterior part of the disc. Using a thin-bladed scalpel A circular excision, approximately one centimeter in diameter, is made in the annulus fibrosus.

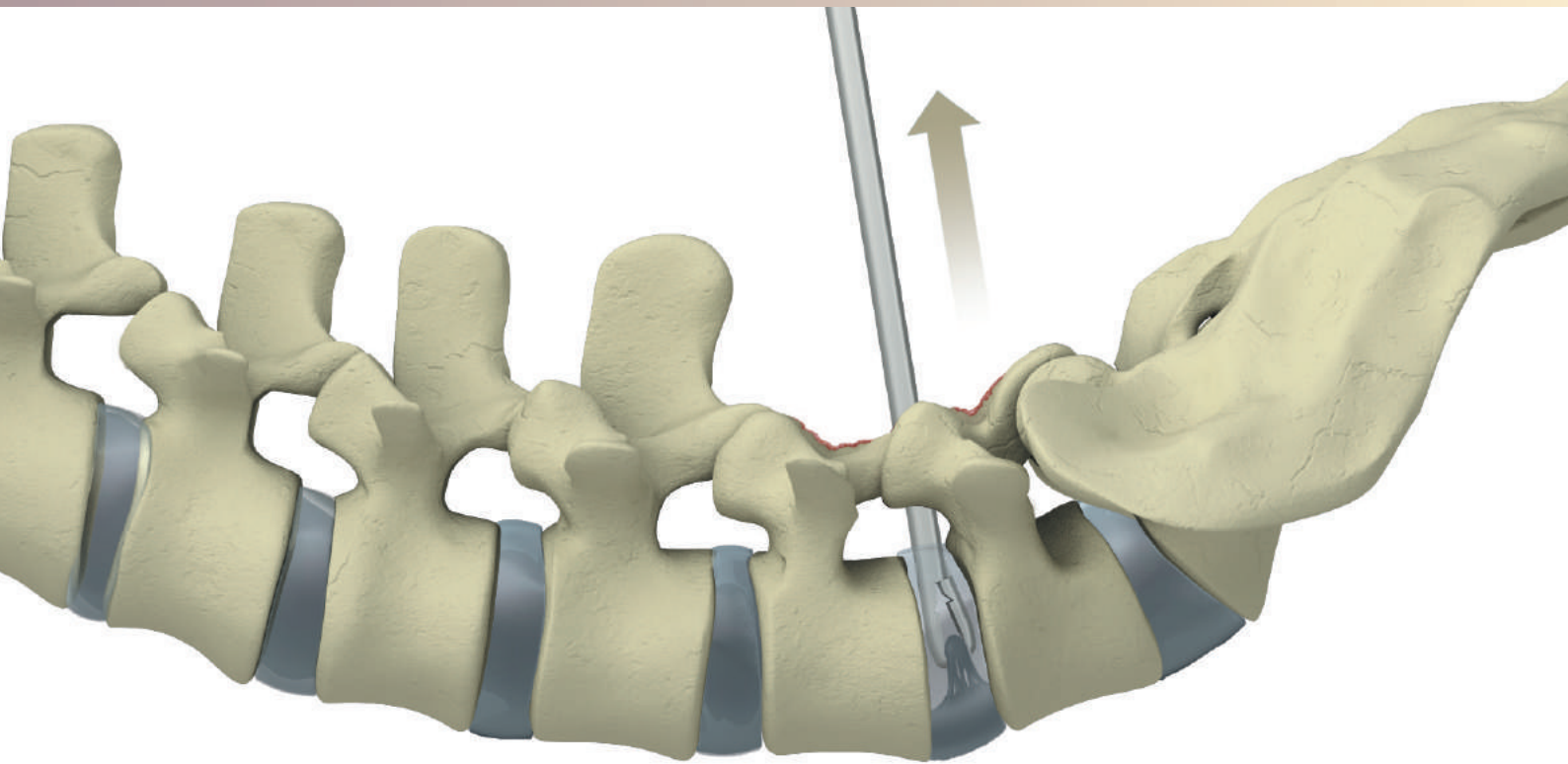

4. Distraction of the Endplates

The disc fragments are removed by the pituitary Rongeur.

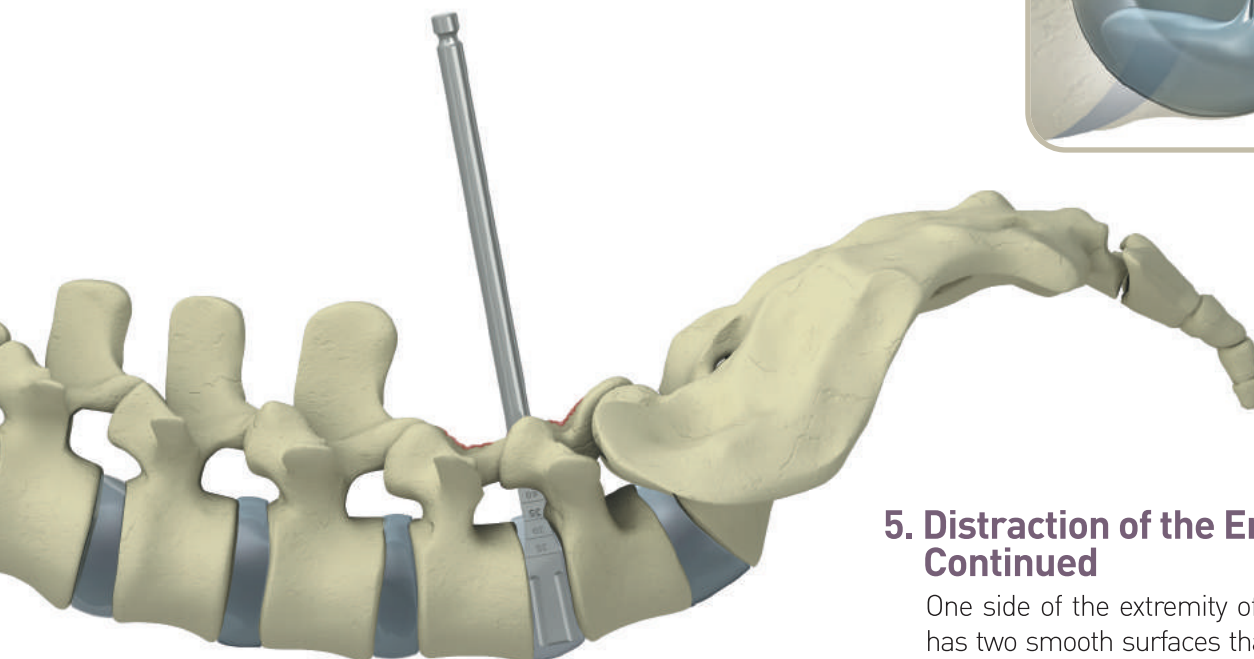
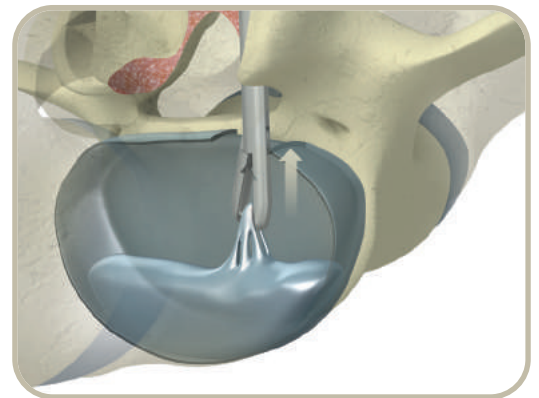

5. Distraction of the Endplate, Continued

One side of the extremity of these instruments has two smooth surfaces that are applied to the endplate to distract the intervertebral body space. The other side of the extremity has two cutting edges that scrape the endplate to expose the subchondral bone. The smallest reamer-distractor is inserted "horizontally" into the intervertebral space. Turning the instrument 90° to widen the intervertebral space

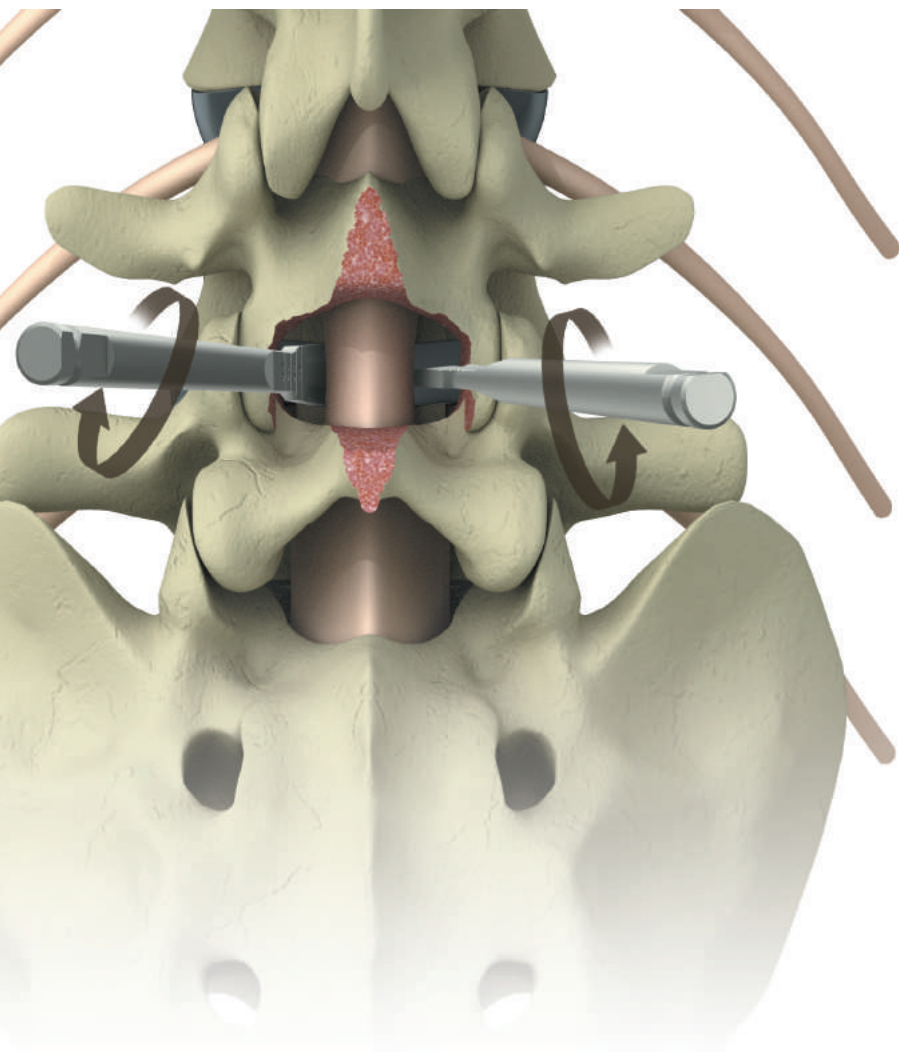

6. Insertion and Rotation

The disc material is completely removed and the endplates are freshened 90° by reamer-distractors. The contralateral instrument is left in the "vertical" position to maintain the width of the intervertebral space.

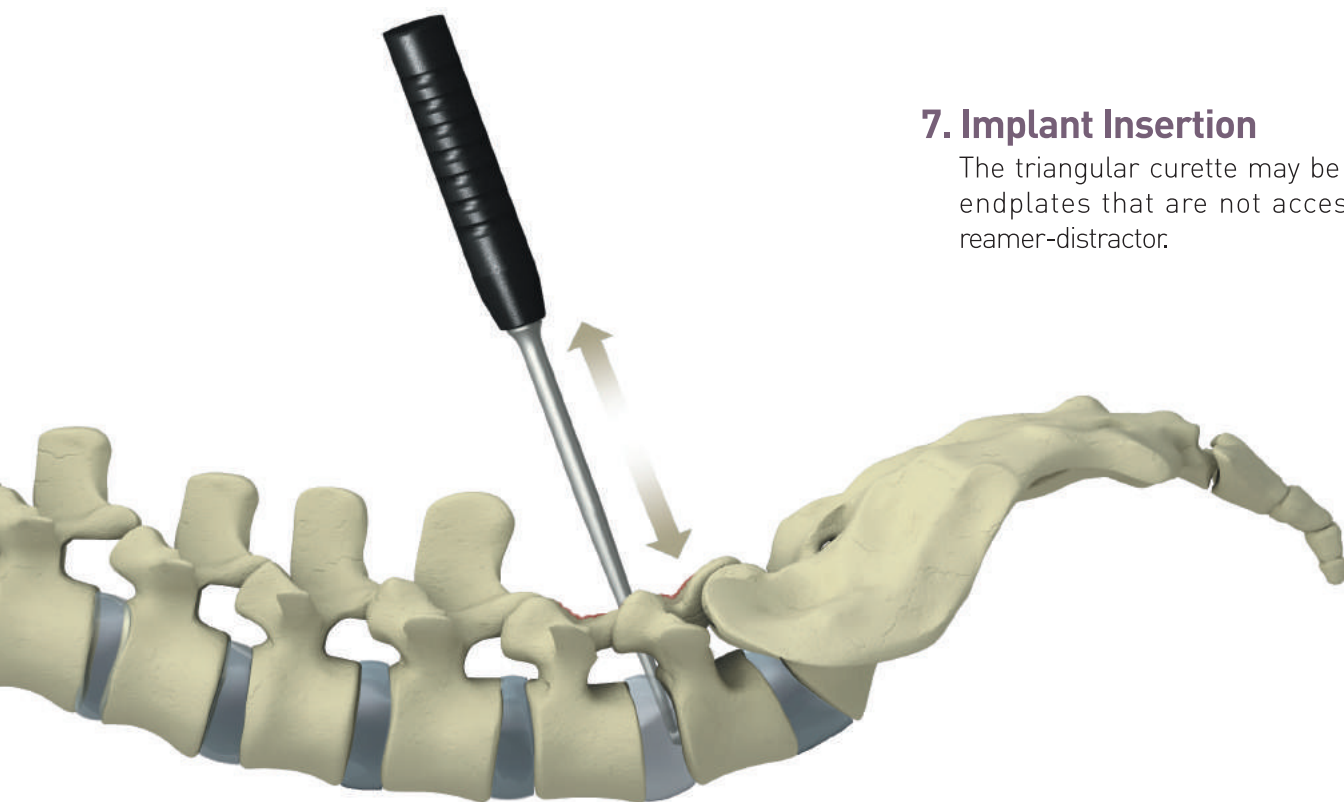
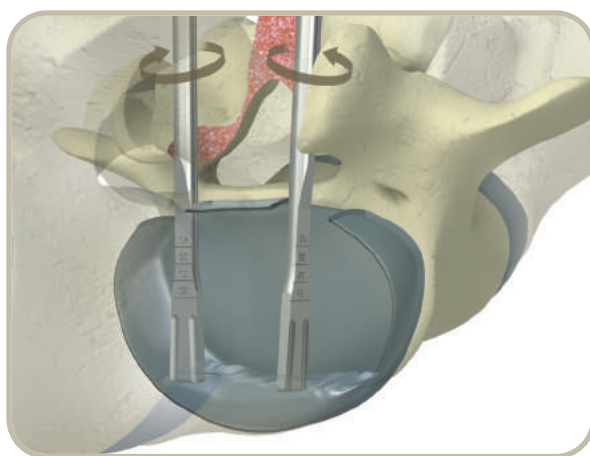

7. Implant Insertion

The triangular curette may be used for the endplates that are not accessible by the reamer-distractor.

8. Implant Insertion, Continued

The cage is holding to the cage impactor and slipped into the cage supporter, in order to fill with pieces of autologous bone. The pieces of bone in the cage are compacted as hard as possible by hand with a graft compactor.

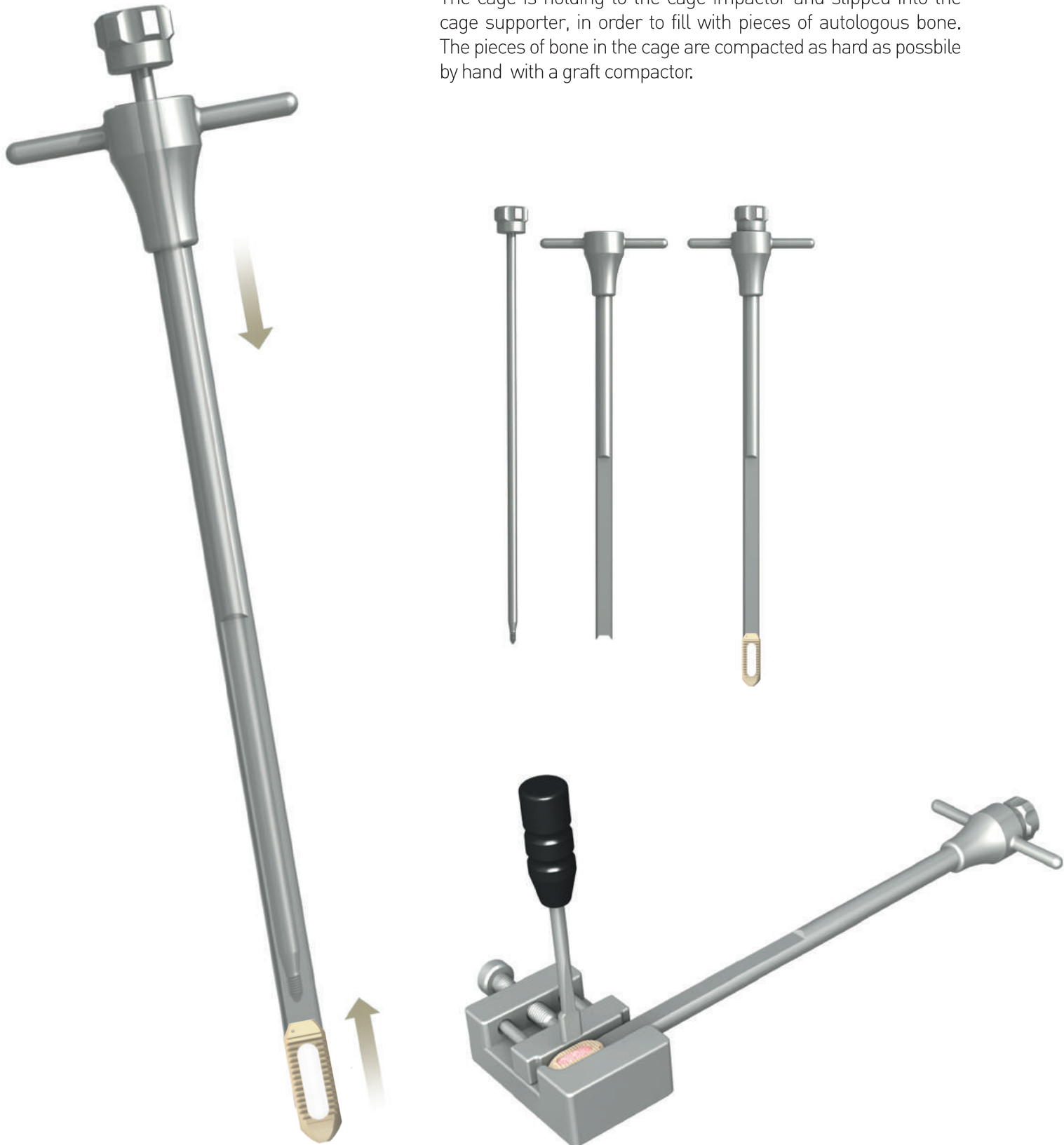

9. Implant Insertion, Continued

The cage should be inserted gently and progressively in a wide opened disc space. The serrated sides are positioned with facing the endplates. To ensure the cage is freely accessible to intervertebral space, the contralateral distractor is left in place during the cage placement.

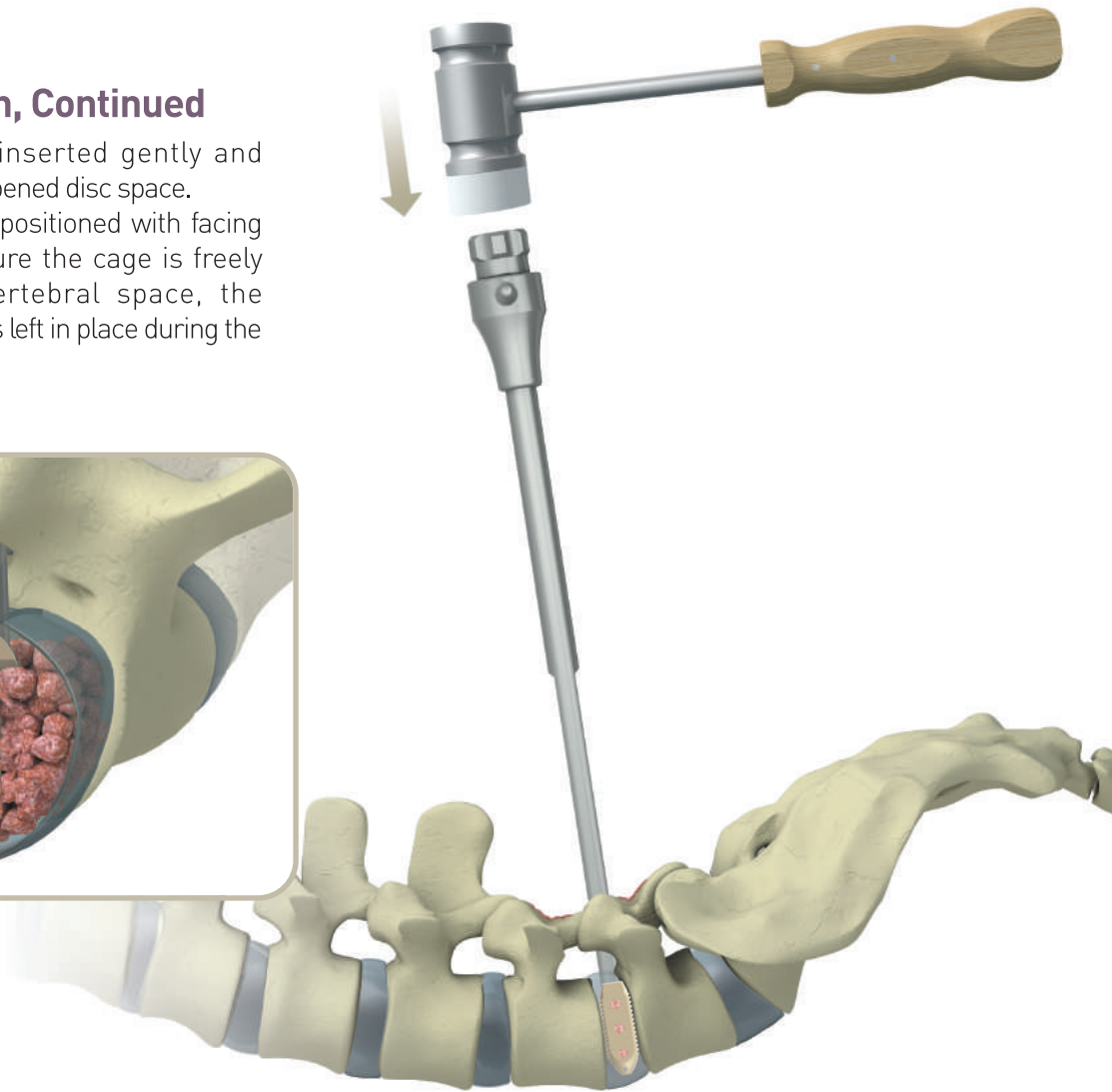
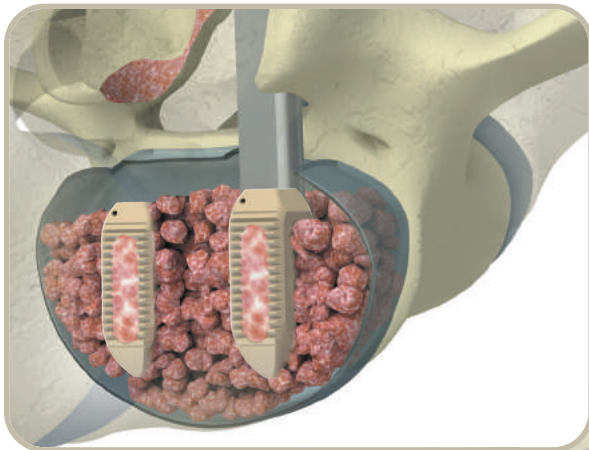

10. Closure

The distractor is removed and the same procedures are carried out on the contralateral side of the intervertebral space.



PEEK PLIF Cage System Implants List

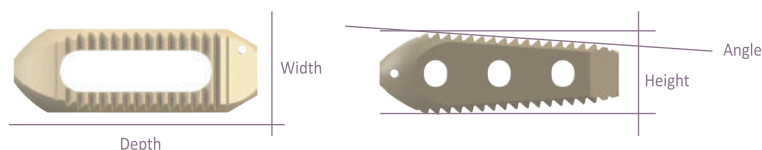

Size = Depth x Width x Height (mm), Angle (°)

25mm PEEK Posterior Lumbar Interbody Fusion Cage

Cat. No	Description	Size
5800-0008	PEEK PLIF Cage	25x11x8mm, 0°
5800-0009	PEEK PLIF Cage	25x11x9mm, 0°
5800-0010	PEEK PLIF Cage	25x11x10mm, 0°
5800-0011	PEEK PLIF Cage	25x11x11mm, 0°
5800-0012	PEEK PLIF Cage	25x11x12mm, 0°
5800-0013	PEEK PLIF Cage	25x11x13mm, 0°
5800-0014	PEEK PLIF Cage	25x11x14mm, 0°

Cat. No	Description	Size
5804-0009	PEEK PLIF Cage	25x11x9mm, 4°
5804-0010	PEEK PLIF Cage	25x11x10mm, 4°
5804-0011	PEEK PLIF Cage	25x11x11mm, 4°
5804-0012	PEEK PLIF Cage	25x11x12mm, 4°
5804-0013	PEEK PLIF Cage	25x11x13mm, 4°
5804-0014	PEEK PLIF Cage	25x11x14mm, 4°

Cat. No	Description	Size
5808-0009	PEEK PLIF Cage	25x11x9mm, 8°
5808-0010	PEEK PLIF Cage	25x11x10mm, 8°
5808-0011	PEEK PLIF Cage	25x11x11mm, 8°
5808-0012	PEEK PLIF Cage	25x11x12mm, 8°
5808-0013	PEEK PLIF Cage	25x11x13mm, 8°
5808-0014	PEEK PLIF Cage	25x11x14mm, 8°

32mm PEEK Posterior Lumbar Interbody Fusion Cage

Cat. No	Description	Size
5800-3208	PEEK PLIF Cage	32x12x8mm, 0°
5800-3209	PEEK PLIF Cage	32x12x9mm, 0°
5800-3210	PEEK PLIF Cage	32x12x10mm, 0°
5800-3211	PEEK PLIF Cage	32x12x11mm, 0°
5800-3212	PEEK PLIF Cage	32x12x12mm, 0°
5800-3213	PEEK PLIF Cage	32x12x13mm, 0°
5800-3214	PEEK PLIF Cage	32x12x14mm, 0°

Cat. No	Description	Size
5804-3209	PEEK PLIF Cage	32x12x9mm, 4°
5804-3210	PEEK PLIF Cage	32x12x10mm, 4°
5804-3211	PEEK PLIF Cage	32x12x11mm, 4°
5804-3212	PEEK PLIF Cage	32x12x12mm, 4°
5804-3213	PEEK PLIF Cage	32x12x13mm, 4°
5804-3214	PEEK PLIF Cage	32x12x14mm, 4°

Cat. No	Description	Size
5808-3210	PEEK PLIF Cage	32x12x10mm, 8°
5808-3211	PEEK PLIF Cage	32x12x11mm, 8°
5808-3212	PEEK PLIF Cage	32x12x12mm, 8°
5808-3213	PEEK PLIF Cage	32x12x13mm, 8°
5808-3214	PEEK PLIF Cage	32x12x14mm, 8°

40mm PEEK Posterior Lumbar Interbody Fusion Cage

Cat. No	Description	Size
5800-4008	PEEK PLIF Cage	40x12x8mm, 0°
5800-4009	PEEK PLIF Cage	40x12x9mm, 0°
5800-4010	PEEK PLIF Cage	40x12x10mm, 0°
5800-4011	PEEK PLIF Cage	40x12x11mm, 0°

28mm PEEK Posterior Lumbar Interbody Fusion Cage

Cat. No	Description	Size
5800-2808	PEEK PLIF Cage	25x11x8mm, 0°
5800-2809	PEEK PLIF Cage	25x11x9mm, 0°
5800-2810	PEEK PLIF Cage	25x11x10mm, 0°
5800-2811	PEEK PLIF Cage	25x11x11mm, 0°
5800-2812	PEEK PLIF Cage	25x11x12mm, 0°
5800-2813	PEEK PLIF Cage	25x11x13mm, 0°
5800-2814	PEEK PLIF Cage	25x11x14mm, 0°

Cat. No	Description	Size
5804-2809	PEEK PLIF Cage	28x11x9mm, 4°
5804-2810	PEEK PLIF Cage	28x11x10mm, 4°
5804-2811	PEEK PLIF Cage	28x11x11mm, 4°
5804-2812	PEEK PLIF Cage	28x11x12mm, 4°
5804-2813	PEEK PLIF Cage	28x11x13mm, 4°
5804-2814	PEEK PLIF Cage	28x11x14mm, 4°

Cat. No	Description	Size
5808-2810	PEEK PLIF Cage	28x11x10mm, 8°
5808-2811	PEEK PLIF Cage	28x11x11mm, 8°
5808-2812	PEEK PLIF Cage	28x11x12mm, 8°
5808-2813	PEEK PLIF Cage	28x11x13mm, 8°
5808-2814	PEEK PLIF Cage	28x11x14mm, 8°

36mm PEEK Posterior Lumbar Interbody Fusion Cage

Cat. No	Description	Size
5800-3608	PEEK PLIF Cage	36x12x8mm, 0°
5800-3609	PEEK PLIF Cage	36x12x9mm, 0°
5800-3610	PEEK PLIF Cage	36x12x10mm, 0°
5800-3611	PEEK PLIF Cage	36x12x11mm, 0°
5800-3612	PEEK PLIF Cage	36x12x12mm, 0°
5800-3613	PEEK PLIF Cage	36x12x13mm, 0°
5800-3614	PEEK PLIF Cage	36x12x14mm, 0°

Cat. No	Description	Size
5804-3609	PEEK PLIF Cage	36x12x9mm, 4°
5804-3610	PEEK PLIF Cage	36x12x10mm, 4°
5804-3611	PEEK PLIF Cage	36x12x11mm, 4°
5804-3612	PEEK PLIF Cage	36x12x12mm, 4°
5804-3613	PEEK PLIF Cage	36x12x13mm, 4°
5804-3614	PEEK PLIF Cage	36x12x14mm, 4°

Cat. No	Description	Size
5808-3611	PEEK PLIF Cage	36x12x11mm, 8°
5808-3612	PEEK PLIF Cage	36x12x12mm, 8°
5808-3613	PEEK PLIF Cage	36x12x13mm, 8°
5808-3614	PEEK PLIF Cage	36x12x14mm, 8°

Cat. No	Description	Size
5800-4012	PEEK PLIF Cage	40x12x12mm, 0°
5800-4013	PEEK PLIF Cage	40x12x13mm, 0°
5800-4014	PEEK PLIF Cage	40x12x14mm, 0°

PEEK PLIF Cage System Instruments List

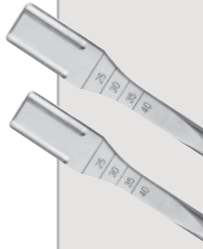

Cat No.	Description	Size
5901-0035	Reamer Sharp	0° × 7mm
5901-1038	Reamer Sharp	0° × 8mm
5901-0036	Reamer Sharp	0° × 9mm
5901-1039	Reamer Sharp	0° × 10mm
5901-0037	Reamer Sharp	0° × 11mm
5901-1040	Reamer Sharp	0° × 12mm
5901-0038	Reamer Sharp	0° × 13mm
5901-1041	Reamer Sharp	0° × 14mm
5901-1039	Reamer Sharp	0° × 15mm



Cat No.	Description	Size
5901-1033	Reamer Sharp	4° × 7mm
5901-1042	Reamer Sharp	4° × 8mm
5901-1034	Reamer Sharp	4° × 9mm
5901-1043	Reamer Sharp	4° × 10mm
5901-1035	Reamer Sharp	4° × 11mm
5901-1044	Reamer Sharp	4° × 12mm
5901-1036	Reamer Sharp	4° × 13mm
5901-1045	Reamer Sharp	4° × 14mm
5901-1037	Reamer Sharp	4° × 15mm



Cat No.	Description	Size
5901-0040	Reamer Blunt	7mm
5901-1046	Reamer Blunt	8mm
5901-0041	Reamer Blunt	9mm
5901-1047	Reamer Blunt	10mm
5901-0042	Reamer Blunt	11mm
5901-1048	Reamer Blunt	12mm
5901-0043	Reamer Blunt	13mm
5901-1049	Reamer Blunt	14mm
5901-0044	Reamer Blunt	15mm



Cat No.	Description	Size
5901-0032	Bone Curette	Angled / Left
5901-0033	Bone Curette	Angled / Right



Cat No.	Description	Size
5901-0029	Osteotome	Angled / Left
5901-0030	Osteotome	Angled / Right



Cat No.	Description
5901-0045	T-Handle



Cat No.	Description
5901-0050	PLIF Last Impactor



Cat No.	Description
5901-0026	PEEK PLIF Cage Holder



Cat No.	Description
5901-0047	Graft Impactor



Cat No.	Description	Size
29-17014	Durameter Retractor	16×215mm

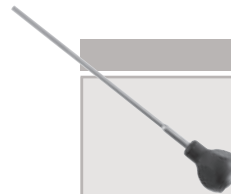

Cat No.	Description
5901-0051	Cancellous Bone Impactor



Cat No.	Description
5901-0046	Graft Holder



Cat No.	Description
5901-0027	Cancellous Bone Funnel

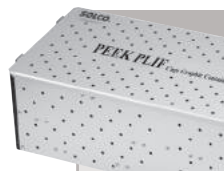

Cat No.	Description
9901-5008	PEEK PLIF Cage Graphic Container

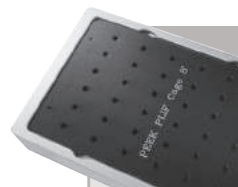

Cat No.	Description	Size
9901-5009	PEEK PLIF Cage Implant Case	0°
9901-5010	PEEK PLIF Cage Implant Case	4°
9901-5011	PEEK PLIF Cage Implant Case	8°

* The design of products can be amended without prior consent.



PEEK PLIF Cage System

SOLCO.

LIFE & SCIENCE

www.solcobiomedical.com

HEAD OFFICE

13F, #505-14, Gasan-dong, Geumcheon-gu, Seoul 158-803 Korea
Tel. +82-2-2082-7700 Fax. +82-2-2082-7701

SEOUL OFFICE

#34-6, Keumam-ri, Seotan-myeon, Pyeongtaek, Gyeonggi-do 451-852 Korea
Tel. +82-31-664-4101 Fax. +82-31-663-6520